



0.1 Hz to 102.4 kHz 8-Bit Programmable

2" x 4" 8-Pole Filters

Description

The 858 Series are digitally programmable low pass and high-pass active filters that are tunable over a 256:1 frequency range. 858 filters are available with any one of six standard factory-set tuning ranges up to 102.4 kHz. These units contain 8 CMOS logic inputs that can be operated in a transparent or latching mode.

All 858 Series models are convenient, low profile, easy to use fully finished filters which require no external components or adjustments. They feature low harmonic distortion, and near theoretical phase and amplitude characteristics. 858 filters operate from non-critical ± 12 to ± 18 Vdc power supplies, have a 10 k Ω (min.) input impedance, a 10 Ω (max.) output impedance and offer dc voltage offset adjustment.

Features/Benefits:

- Lower cost, high precision replacement for 848 and 878 series products.
- Low harmonic distortion and wide signal-to-noise ratio to 16 bit resolution.
- Digitally programmable corner frequency allows selecting cut-off frequencies specific to each application.
- Plug-in ready-to-use, reducing engineering design and manufacturing cycle time.
- Factory-set tuning range, no external clocks or adjustments needed.
- Broad range of transfer characteristics and corner frequencies to meet a wide range of applications.

Applications

- Anti-alias filtering
- Data acquisition systems
- Communication systems and electronics
- Medical electronics equipment and research
- Aerospace, navigation and sonar applications
- Sound and vibration testing
- Real and compressed time data analysis
- Noise elimination
- Signal reconstruction



Programmable Specifications:	Page
Digital Tuning & Control	2
Available Low-Pass Models:	
858L8B 8-pole Butterworth	3
858L8E 8-pole, 6 zero elliptic, 1.77 (-80dB)	3
858L8EX 8-pole, 6 zero elliptic, 1.56 (-80dB)	3
858L8EY 8-pole, 6 zero elliptic, 2.00 (-100dB)	3
858L8L 8-pole Bessel	4
858L8D60 8-pole constant delay (-60dB)	4
858L8D80 8-pole constant delay (-80dB)	4
858L8D108 8-pole constant delay (-100dB)	4
Available High-Pass Models:	
858H8B 8-pole Butterworth	5
858H8E 8-pole, 6 zero elliptic, 1.77 (-80dB)	5
858H8EX 8-pole, 6 zero elliptic, 1.56 (-80dB)	5
858H8EY 8-pole, 6 zero elliptic, 2.00 (-100dB)	5
General Specifications:	
Ordering information	6
Pin-out/package data	6



Digital Tuning & Control Characteristics

8-Bit Programmable Filters

Digital Tuning Characteristics

The digital tuning interface circuits are two 4042 quad CMOS latches which accept the following CMOS-compatible inputs: eight tuning bits (D₀ - D₇), a latch strobe bit (C), and a transition polarity bit (P).

Filter tuning follows the tuning equation given below:

$$f_c = (f_{max}/256) [1 + D_7 \times 2^7 + D_6 \times 2^6 + D_5 \times 2^5 + D_4 \times 2^4 + D_3 \times 2^3 + D_2 \times 2^2 + D_1 \times 2^1 + D_0 \times 2^0]$$

where D₁ - D₇ = "0" or "1", and

f_{max} = Maximum tuning frequency;

f_c = corner frequency;

Minimum tunable frequency = f_{max}/256 (D₀ thru D₇ = 0);

Minimum frequency step (Resolution) = f_{max}/256

Data Input Specifications

Data Control Lines

Functions Latch Strobe (C)
 Transition Polarity (P)

Data Control Modes

Mode 1 P = 0; C = 0 frequency follows input codes
 P = 0; C = 0↑ frequency latched on rising edge

Mode 2 P = 1; C = 1 frequency follows input codes
 P = 1; C = 1↓ frequency latched on falling edge

Input Data Levels (CMOS Logic)

Input Voltage (Vs = 15 Vdc)

Low Level In 0 Vdc min. 4 Vdc max.
High Level In 11 Vdc min. 15 Vdc max.

Input Current

High Level In - 10⁻⁵ μA typ. -1 μA max..
Low Level In +10⁻⁵ μA typ. +1 μA max.

Input Capacitance

5 pF typ 7.5 pF max.

Input Data Format Frequency Select Bits

Positive Logic Logic "1" = +Vs
 Logic "0" = Gnd

Bit Weighting

(Binary-Coded)
D₀ LSB (least significant bit)
D₇ MSB (most significant bit)

Frequency Range 256 : 1, Binary Weighted

Pin-Out Key

IN	Analog Input Signal	D ₇ Tuning Bit 7 (MSB)
OUT	Analog Output Signal	D ₆ Tuning Bit 6
GND	Power and Signal Return	D ₅ Tuning Bit 5
"P"	Transition Polarity Bit	D ₄ Tuning Bit 4
"C"	Tuning Strobe Bit	D ₃ Tuning Bit 3
+Vs	Supply Voltage, Positive	D ₂ Tuning Bit 2
-Vs	Supply Voltage, Negative	D ₁ Tuning Bit 1
Os	Offset Adjustment	D ₀ Tuning Bit 0 (LSB)

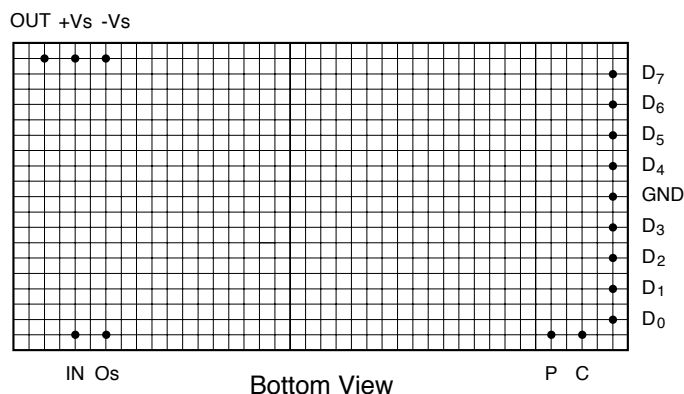

MSB	---	---	---	---	---	---	LSB	Bit Weight
2 ⁷	2 ⁶	2 ⁵	2 ⁴	2 ³	2 ²	2 ¹	2 ⁰	f _c Corner Frequency
D ₇	D ₆	D ₅	D ₄	D ₃	D ₂	D ₁	D ₀	
0	0	0	0	0	0	0	0	f _{max} /256
0	0	0	0	0	0	0	1	f _{max} /128
0	0	0	0	0	0	1	1	f _{max} /64
0	0	0	0	0	1	1	1	f _{max} /32
0	0	0	0	1	1	1	1	f _{max} /16
0	0	0	1	1	1	1	1	f _{max} /8
0	0	1	1	1	1	1	1	f _{max} /4
0	1	1	1	1	1	1	1	f _{max} /2
1	1	1	1	1	1	1	1	f _{max}

Notes:
1. Frequency data must be present before occurrence of strobe edge.
2. Frequency data must be present after occurrence of strobe edge.



8-Bit Programmable

8-Pole Low-Pass Filters

Model	858L8B	858L8E	858L8EX	858L8EY
Product Specifications				
Transfer Function	8-Pole Butterworth	8-Pole, 6 zero Elliptic	8-Pole, 6 zero Elliptic	8-Pole, 6 zero Elliptic
Size, Model 2 Model 3 thru 6	4.0" x 2.0" x 0.6" 4.0" x 2.0" x 0.4"	4.0" x 2.0" x 0.6" 4.0" x 2.0" x 0.4"	4.0" x 2.0" x 0.6" 4.0" x 2.0" x 0.4"	4.0" x 2.0" x 0.6" 4.0" x 2.0" x 0.4"
Range f_c, f_r	0.1 Hz to 102.4 kHz	0.1 Hz to 102.4 kHz	0.1 Hz to 102.4 kHz	0.1 Hz to 102.4 kHz
Theoretical Transfer Characteristics	Appendix A Page 9	Appendix A Page 24	Appendix A Page 23	Appendix A Page 25
Passband Ripple (theoretical)	0.0 dB	± 0.035 dB	0.05 dB	0.05 dB
DC Voltage Gain (non-inverting)	0 ± 0.1 dB max. 0 ± 0.05 dB typ.	0 ± 0.1 dB max. 0 ± 0.05 dB typ.	0 ± 0.1 dB max. 0 ± 0.05 dB typ.	0 ± 0.1 dB max. 0 ± 0.05 dB typ.
Stopband Attenuation Rate	48 dB/octave	80 dB min.	80 dB min.	100 dB min.
Cutoff Frequency Stability Amplitude Phase	$f_c \pm 2\%$ max. $\pm 0.01\%$ /°C - 3 dB -360°	$f_r \pm 2\%$ max. $\pm 0.01\%$ /°C - 0.035 dB -323.5°	$f_r \pm 2\%$ max. $\pm 0.01\%$ /°C - 0.05 dB -414°	$f_r \pm 2\%$ max. $\pm 0.01\%$ /°C - 0.05 dB -419°
Filter Attenuation (theoretical)	0.12 dB 0.80 f_c 3.01 dB 1.00 f_c 60.0 dB 2.37 f_c 80.0 dB 3.16 f_c	0.035 dB 1.00 f_r 3.01 dB 1.13 f_r 60.0 dB 1.67 f_r 80.0 dB 1.77 f_r	0.5 dB 1.00 f_r 3.01 dB 1.05 f_r 60.0 dB 1.45 f_r 80.0 dB 1.56 f_r	0.5 dB 1.00 f_r 3.01 dB 1.06 f_r 80.0 dB 1.83 f_r 100.0 dB 2.00 f_r
Phase Match¹	0 - 0.8 $f_c \pm 2^\circ$ max. $\pm 1^\circ$ typ. 0.8 f_c - 1.0 $f_c \pm 3^\circ$ max. $\pm 1.5^\circ$ typ.	0 - 0.8 $f_r \pm 2^\circ$ max. $\pm 1^\circ$ typ. 0.8 f_r - 1.0 $f_r \pm 4^\circ$ max. $\pm 2^\circ$ typ.	0 - 0.8 $f_r \pm 3^\circ$ max. $\pm 1.5^\circ$ typ. 0.8 f_r - 1.0 $f_r \pm 4^\circ$ max. $\pm 2^\circ$ typ.	0 - 0.8 $f_r \pm 3^\circ$ max. $\pm 1.5^\circ$ typ. 0.8 f_r - 1.0 $f_r \pm 4^\circ$ max. $\pm 2^\circ$ typ.
Amplitude Accuracy (theoretical)	0 - 0.8 $f_c \pm 0.2$ dB max. ± 0.1 dB typ. 0.8 f_c - 1.0 $f_c \pm 0.3$ dB max. ± 0.15 dB typ.	0 - 0.8 $f_r \pm 0.2$ dB max. ± 0.1 dB typ. 0.8 f_r - 1.0 $f_r \pm 0.3$ dB max. ± 0.15 dB typ.	0 - 0.8 $f_r \pm 0.2$ dB max. ± 0.1 dB typ. 0.8 f_r - 1.0 $f_r \pm 0.5$ dB max. ± 0.25 dB typ.	0 - 0.8 $f_r \pm 0.2$ dB max. ± 0.1 dB typ. 0.8 f_r - 1.0 $f_r \pm 0.5$ dB max. ± 0.25 dB typ.
Total Harmonic Distortion @ 1 kHz	< - 100 dB typ.	< - 88 dB typ.	< - 88 dB typ.	< - 88 dB typ.
Wide Band Noise (5 Hz - 2 MHz)	200 μ Vrms typ.	200 μ Vrms typ.	250 μ Vrms typ.	250 μ Vrms typ.
Narrow Band Noise (5 Hz - 100 kHz)	50 μ Vrms typ.	50 μ Vrms typ.	75 μ Vrms typ.	75 μ Vrms typ.
Filter Mounting Assembly	FMA-03A	FMA-03A	FMA-03A	FMA-03A

1. Unit to unit match for the same transfer function, set to the same frequency and operating configuration, and from the same manufacturing lot.



8-Bit Programmable

8-Pole Low-Pass Filters

Model	858L8L	858L8D60	858L8D80	858L8D10
Product Specifications				
Transfer Function	8-Pole Bessel	8-Pole, 6 zero Constant Delay	8-Pole, 6 zero Constant Delay	8-Pole, 6 zero Constant Delay
Size, Model 2 Model 3 thru 6	4.0" x 2.0" x 0.6" 4.0" x 2.0" x 0.4"	4.0" x 2.0" x 0.6" 4.0" x 2.0" x 0.4"	4.0" x 2.0" x 0.6" 4.0" x 2.0" x 0.4"	4.0" x 2.0" x 0.6" 4.0" x 2.0" x 0.4"
Range f_c	0.1 Hz to 102.4 kHz	0.1 Hz to 102.4 kHz	0.1 Hz to 102.4 kHz	0.1 Hz to 102.4 kHz
Theoretical Transfer Characteristics	Appendix A Page 4	Appendix A Page 20	Appendix A Page 21	Appendix A Page 22
Passband Ripple (theoretical)	0.0 dB	0.15 dB	0.15 dB	0.15 dB
DC Voltage Gain (non-inverting)	0 ± 0.1 dB max. 0 ± 0.05 dB typ.	0 ± 0.1 dB max. 0 ± 0.05 dB typ.	0 ± 0.1 dB max. 0 ± 0.05 dB typ.	0 ± 0.1 dB max. 0 ± 0.05 dB typ.
Stopband Attenuation Rate	48 dB/octave	60 dB min.	80 dB min.	100 dB min.
Cutoff Frequency Stability Amplitude Phase	f_c ± 2% max. ± 0.01% /°C - 3 dB -182°	f_c ± 2% max. ± 0.01% /°C - 3 dB -306°	f_c ± 2% max. ± 0.01% /°C - 3 dB -306°	f_c ± 2% max. ± 0.01% /°C - 3 dB -311°
Filter Attenuation (theoretical)	1.91 dB 0.80 f_c 3.01 dB 1.00 f_c 60.0 dB 4.52 f_c 80.0 dB 6.07 f_c	3.01 dB 1.00 f_c 40.0 dB 2.28 f_c 60.0 dB 2.64 f_c	3.01 dB 1.00 f_c 60.0 dB 3.08 f_c 80.0 dB 3.57 f_c	3.01 dB 1.00 f_c 80.0 dB 4.45 f_c 100.0 dB 5.20 f_c
Phase Match¹	0 - f_c ± 2° max. ± 1° typ.	0 - f_c ± 2° max. ± 1° typ.	0 - f_c ± 2° max. ± 1° typ.	0 - f_c ± 2° max. ± 1° typ.
Amplitude Accuracy (theoretical)	0 - f_c ± 0.2 dB max. ± 0.1 dB typ.	0 - 0.8 f_c ± 0.2 dB max. ± 0.1 dB typ. 0.8 f_c - 1.0 f_c ± 0.3 dB max. ± 0.15 dB typ.	0 - 0.8 f_c ± 0.2 dB max. ± 0.1 dB typ. 0.8 f_c - 1.0 f_c ± 0.3 dB max. ± 0.15 dB typ.	0 - 0.8 f_c ± 0.2 dB max. ± 0.1 dB typ. 0.8 f_c - 1.0 f_c ± 0.3 dB max. ± 0.15 dB typ.
Total Harmonic Distortion @ 1 kHz	< - 100 dB typ.	< - 100 dB typ.	< - 100 dB typ.	< - 100 dB typ.
Wide Band Noise (5 Hz - 2 MHz)	200 μ Vrms typ.	200 μ Vrms typ.	200 μ Vrms typ.	200 μ Vrms typ.
Narrow Band Noise (5 Hz - 100 kHz)	50 μ Vrms typ.	50 μ Vrms typ.	50 μ Vrms typ.	50 μ Vrms typ.
Filter Mounting Assembly	FMA-03A	FMA-03A	FMA-03A	FMA-03A

1. Unit to unit match for the same transfer function, set to the same frequency and operating configuration, and from the same manufacturing lot.



8-Bit Programmable

8-Pole High-Pass Filters

Model	858H8B	858H8E	858H8EX	858H8EY
Product Specifications				
Transfer Function	8-Pole Butterworth	8-Pole, 6 zero Elliptic	8-Pole, 6 zero Elliptic	8-Pole, 6 zero Elliptic
Size, Model 2 Model 3 thru 6	4.0" x 2.0" x 0.6" 4.0" x 2.0" x 0.4"	4.0" x 2.0" x 0.6" 4.0" x 2.0" x 0.4"	4.0" x 2.0" x 0.6" 4.0" x 2.0" x 0.4"	4.0" x 2.0" x 0.6" 4.0" x 2.0" x 0.4"
Range f_c, fr	0.1 Hz to 102.4 kHz	0.1 Hz to 102.4 kHz	0.1 Hz to 102.4 kHz	0.1 Hz to 102.4 kHz
Theoretical Transfer Characteristics	Appendix A Page 29	Appendix A Page 37	Appendix A Page 36	Appendix A Page 38
Passband Ripple (theoretical)	0.0 dB	± 0.035 dB	- 0.05 dB	- 0.05 dB
Voltage Gain (non-inverting)	0 ± 0.2 dB to 100 kHz 0 ± 0.5 dB to 120 kHz	0 ± 0.2 dB to 100 kHz 0 ± 0.5 dB to 120 kHz	0 ± 0.2 dB to 100 kHz 0 ± 0.5 dB to 120 kHz	0 ± 0.2 dB to 100 kHz 0 ± 0.5 dB to 120 kHz
Power Bandwidth	120 kHz	120 kHz	120 kHz	120 kHz
Small Signal Bandwidth	(-6 dB) 1 MHz	(-6 dB) 1 MHz	(-6 dB) 1 MHz	(-6 dB) 1 MHz
Stopband Attenuation Rate	48 dB/octave	80 dB	80 dB	100 dB
Cutoff Frequency Stability Amplitude Phase	f_c ± 2% max. ± 0.01% /°C - 3 dB -360°	f_r ± 2% max. ± 0.01% /°C - 0.035 dB -323.5°	f_r ± 2% max. ± 0.01% /°C - 0.05 dB -414°	f_r ± 2% max. ± 0.01% /°C - 0.05 dB -419°
Filter Attenuation (theoretical)	80 dB 0.31 f_c 60.0 dB 0.42 f_c 3.01 dB 1.00 f_c 0.00 dB 2.00 f_c	80 dB 0.56 f_r 60.0 dB 0.60 f_r 3.01 dB 0.88 f_r 0.03 dB 1.00 f_r 0.00 dB 2.00 f_r	80 dB 0.64 f_r 60.0 dB 0.69 f_r 3.01 dB 0.95 f_r 0.03 dB 1.00 f_r 0.00 dB 2.00 f_r	100 dB 0.50 f_r 80.0 dB 0.55 f_r 3.01 dB 0.94 f_r 0.03 dB 1.00 f_r 0.00 dB 2.00 f_r
Phase Match¹	f_c - 100 kHz ± 3° max. ± 1.5° typ.	f_r - 1.25 f_r ± 4° max. ± 2° typ. 1.25 f_r -100 kHz ± 2° max. ± 1° typ.	f_r - 1.25 f_r ± 4° max. ± 2° typ. 1.25 f_r -100 kHz ± 2° max. ± 1° typ.	f_r - 1.25 f_r ± 4° max. ± 2° typ. 1.25 f_r -100 kHz ± 3° max. ± 1.5° typ.
Amplitude Accuracy (theoretical)	f_c -1.25 f_c ± 0.30 dB max. ± 0.15 dB typ. 1.25 f_c -100 kHz ± 0.20 dB max. ± 0.10 dB typ.	f_r -1.25 f_r ± 0.3 dB max. ± 0.15 dB typ. 1.25 f_r -100 kHz ± 0.2 dB max. ± 0.1 dB typ.	f_r -1.25 f_r ± 0.5 dB max. ± 0.25 dB typ. 1.25 f_r -100 kHz ± 0.2 dB max. ± 0.1 dB typ.	f_r -1.25 f_r ± 0.5 dB max. ± 0.25 dB typ. 1.25 f_r -100 kHz ± 0.2 dB max. ± 0.1 dB typ.
Total Harmonic Distortion @ 1 kHz	< - 100 dB typ.	< - 88 dB typ.	< - 88 dB typ.	< - 88 dB typ.
Wide Band Noise (5 Hz - 2 MHz)	400 μVrms typ.	400 μVrms typ.	500 μVrms typ.	500 μVrms typ.
Narrow Band Noise (5 Hz - 100 kHz)	100 μVrms typ.	100 μVrms typ.	150 μVrms typ.	150 μVrms typ.
Filter Mounting Assembly	FMA-03A	FMA-03A	FMA-03A	FMA-03A

1. Unit to unit match for the same transfer function, set to the same frequency and operating configuration, and from the same manufacturing lot.



Specification

(25°C and $V_s \pm 15$ Vdc)

Pin-Out and Package Data Ordering Information

Analog Input Characteristics¹

Impedance	10 k Ω min.
Voltage Range	± 10 Vpeak
Max. Safe Voltage	$\pm V_s$

Analog Output Characteristics

Impedance (Closed Loop)	1 Ω typ. 10 Ω max.
Linear Operating Range	± 10 V
Maximum Current ²	± 2 mA
Offset Voltage ³	2 mV typ. 20 mV max.

Offset Temp. Coeff. 50 μ V/°C

Power Supply ($\pm V_s$)

Rated Voltage	± 15 Vdc
Operating Range	± 12 to ± 18 Vdc
Maximum Safe Voltage	± 18 Vdc
Quiescent Current	
8 Pole	± 25 mA typ. ± 40 mA max.

Temperature

Operating	0 to +70°C
Storage	-25 to +85°C

Pin-Out & Package Data

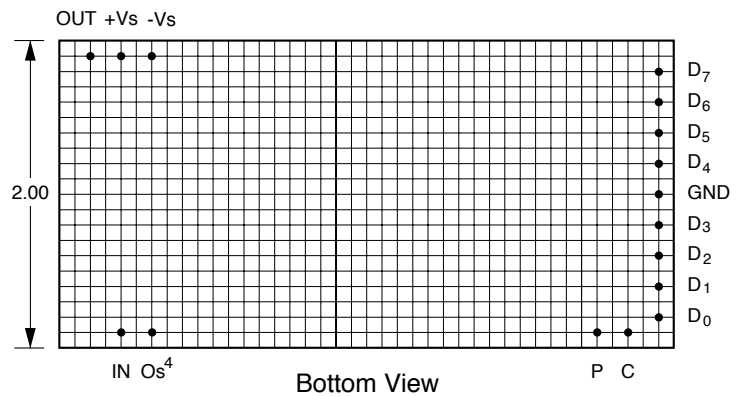
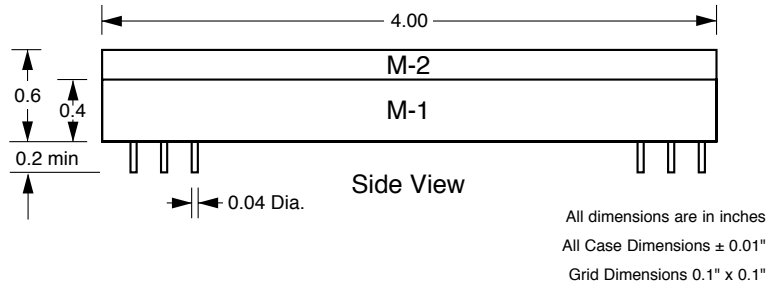

Filter Mounting Assembly-See FMA-03A

Notes:

1. Input and output signal voltage referenced to supply common.
2. Output is short circuit protected to common.
DO NOT CONNECT TO $\pm V_s$.
3. Adjustable to zero.
4. Units operate with or without offset pin connected.

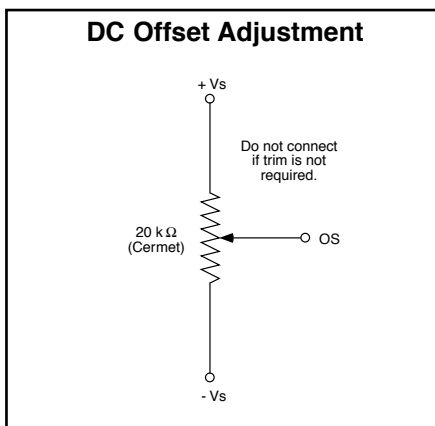

Ordering Information

Filter Type	Transfer Function	Model Number		
L - Low Pass H - High Pass	B - Butterworth L - Bessel D60 - constant delay (-60 dB) D80 - constant delay (-80 dB) D10 - constant delay (-100 dB) E - elliptic 1.77 (-80 dB) EX - elliptic 1.56 (-80 dB) EY - elliptic 2.00 (-100 dB)	858L8B-3		
e.g.,	Model Number	Tuning Range (Hz)	Minimum Step(Hz)	Case
	1	0.1 to 25.6	0.1	M-2
	2	1.0 to 256	1.0	M-2
	3	10 to 2560	10	M-1
	4	100 to 25.6k	100	M-1
	5	200 to 51.2k	200	M-1
	6	400 to 102.4k	400	M-1

We hope the information given here will be helpful. The information is based on data and our best knowledge, and we consider the information to be true and accurate. Please read all statements, recommendations or suggestions herein in conjunction with our conditions of sale which apply to all goods supplied by us. We assume no responsibility for the use of these statements, recommendations or suggestions, nor do we intend them as a recommendation for any use which would infringe any patent or copyright. **IN-00858-00**



Programmable Filter Modules Power Sequence & ESD

November 2000

Programmable Filters Modules

818, 824, 828, 828BP, 828BR, 854, 858, R854, R858

I. Scope

The following precautions are necessary when handling and installing Frequency Devices programmable filter modules.

II. Digital Circuit Description

The digital input pins connect directly to 4000 series CMOS logic, such as the 4053 analog switch. The power supply (V_{ss}) for the digital logic on the module comes directly from the +15 Volt pin on the module. This sets the threshold voltage at 11.0 V minimum to 15.0 V maximum for a "1" (High) level and 0.0 V minimum to 4.0 V maximum for a "0" (Low) level. Applying a voltage between 4.0 and 11.0 V will produce unpredictable operation. Connecting 5 Volt or 3.3 V logic devices directly to the filter module without using a voltage translator will result in erratic operation of the filter.

III. (VERY IMPORTANT) Power-Up and Power-Down Sequence

Do not plug-in or un-plug module while power is applied. It is imperative that power is supplied to the + 15 V pin on the filter module before or at the same instance that any digital pin is pulled High (> 0.0 V). Failure to do this will result in excessive current flowing through the digital input pin and through a protection diode internal to the 4000 logic, which will result in damage to the module. The proper power-up and power-down sequence is:

1. Connect filter module ground.
2. Connect filter module +15 V.
3. Connect filter module -15 V.
4. Connect the input signal.

All four of the above steps can also occur simultaneously. Power-down should occur in the reverse order.

IV. ESD Issues

Like most modern electronic equipment, the modules can be damaged by electrostatic discharge (ESD). The modules are shipped from the factory in sealed, anti-static packaging and should be kept in the sealed package prior to mounting on a circuit board. The following additional rules should also be observed when handling the modules after they are removed from the factory packaging:

1. Only a person wearing a properly grounded wrist strap should handle the modules.
2. Any work surface that the modules are placed on must be properly ESD grounded.
3. Any insulating materials capable of generating static charge (such as paper) should be kept away from the modules.

Static generating clothing should be covered with an ESD-protective smock.



Appendix A

Theoretical Transfer Characteristics

f/fc (Hz)	Amp (dB)	Phase (deg)	Delay ¹ (sec)
0.00	0.00	0.00	.506
0.10	-0.029	-18.2	.506
0.20	-0.117	-36.4	.506
0.30	-0.264	-54.7	.506
0.40	-0.470	-72.9	.506
0.50	-0.737	-91.1	.506
0.60	-1.06	-109	.506
0.70	-1.45	-128	.506
0.80	-1.91	-146	.506
0.85	-2.16	-155	.506
0.90	-2.42	-164	.506
0.95	-2.71	-173	.506
1.00	-3.01	-182	.506
1.10	-3.67	-200	.506
1.20	-4.40	-219	.506
1.30	-5.20	-237	.506
1.40	-6.10	-255	.505
1.50	-7.08	-273	.504
1.60	-8.16	-291	.502
1.70	-9.36	-309	.498
1.80	-10.7	-327	.492
1.90	-12.1	-345	.482
2.00	-13.7	-362	.468
2.25	-18.1	-402	.417
2.50	-23.1	-436	.352
2.75	-28.3	-465	.291
3.00	-33.4	-489	.241
3.25	-38.3	-509	.201
3.50	-43.1	-526	.170
4.00	-51.8	-552	.126
5.00	-66.8	-587	.077
6.00	-79.2	-610	.052
7.00	-89.8	-626	.038
8.00	-99.0	-638	.029
9.00	-107	-647	.023
10.0	-114	-655	.018

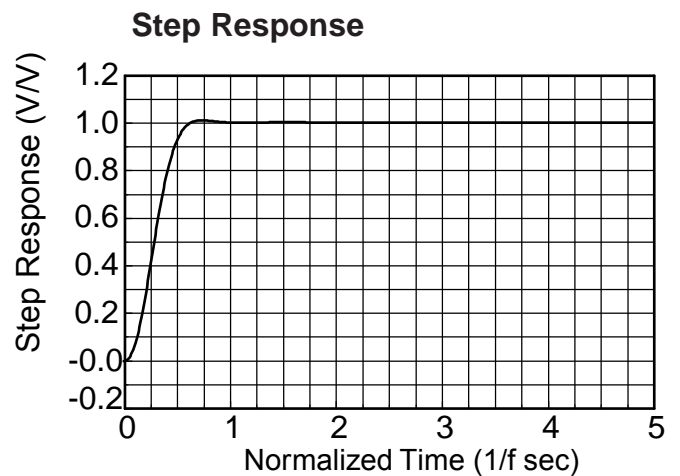
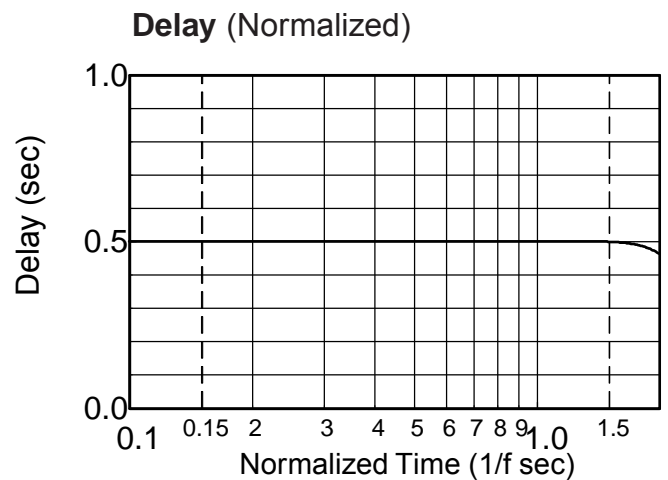
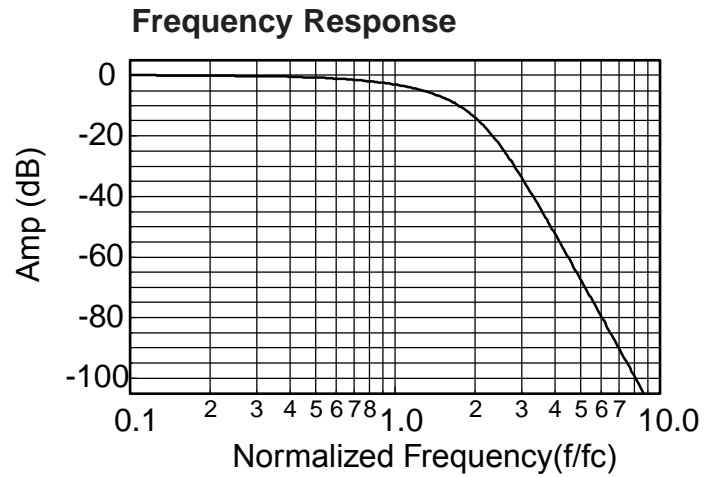

¹ **Normalized Group Delay:**
The above delay data is normalized to a corner frequency of 1.0Hz. The actual delay is the normalized delay divided by the actual corner frequency (fc).

$$\text{Actual Delay} = \frac{\text{Normalized Delay}}{\text{Actual Corner Frequency (fc) in Hz}}$$



Appendix A

Theoretical Transfer Characteristics

f/fc (Hz)	Amp (dB)	Phase (deg)	Delay ¹ (sec)
0.00	0.00	0.00	.816
0.10	0.00	-29.4	.819
0.20	0.00	-59.0	.828
0.30	0.00	-89.1	.843
0.40	0.00	-120	.867
0.50	0.00	-152	.903
0.60	-0.001	-185	.956
0.70	-0.014	-221	1.04
0.80	-0.121	-261	1.19
0.85	-0.311	-283	1.29
0.90	-0.738	-307	1.40
0.95	-1.58	-333	1.48
1.00	-3.01	-360	1.46
1.10	-7.48	-408	1.17
1.20	-12.9	-445	.873
1.30	-18.2	-472	.672
1.40	-23.4	-494	.540
1.50	-28.2	-511	.448
1.60	-32.7	-526	.380
1.70	-36.9	-539	.328
1.80	-40.8	-550	.287
1.90	-44.6	-560	.253
2.00	-48.2	-568	.226
2.25	-56.3	-586	.174
2.50	-63.7	-600	.139
2.75	-70.3	-611	.113
3.00	-76.3	-621	.094
3.25	-81.9	-629	.080
3.50	-87.1	-635	.069
4.00	-96.3	-646	.052
5.00	-112	-661	.033
6.00	-125	-671	.023
7.00	-135	-678	.017
8.00	-144	-683	.013
9.00	-153	-687	.010
10.0	-160	-691	.008

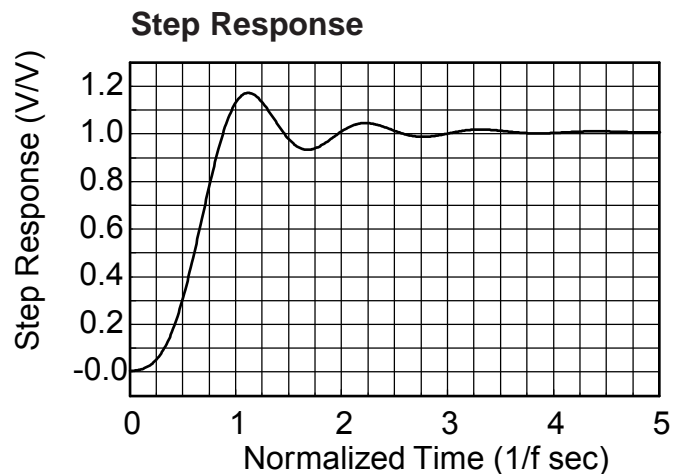
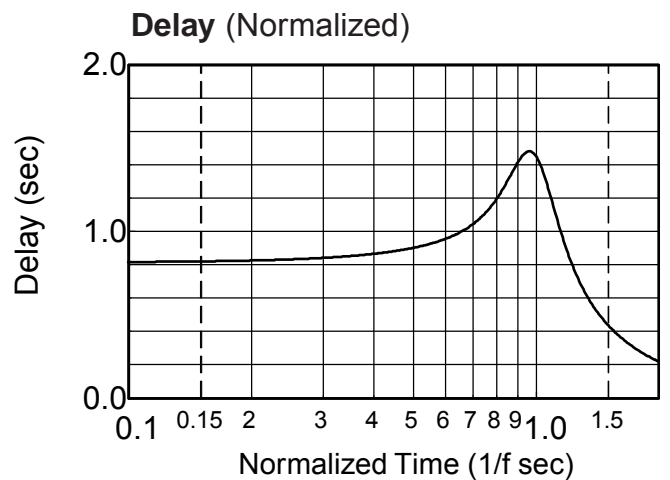
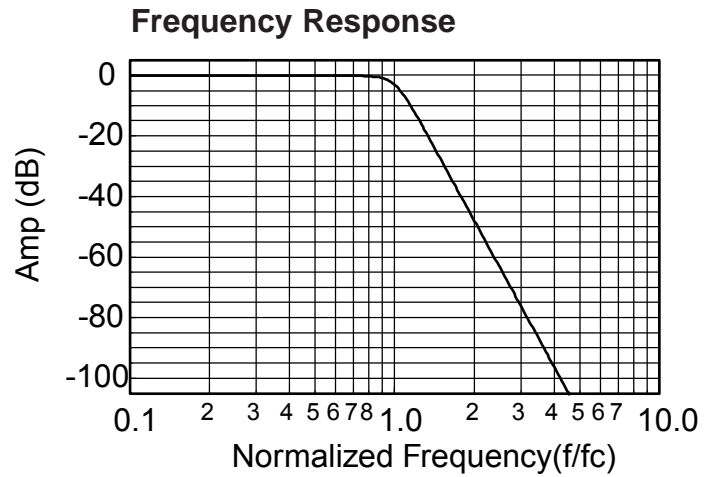

1. Normalized Group Delay:

The above delay data is normalized to a corner frequency of 1.0Hz. The actual delay is the normalized delay divided by the actual corner frequency (fc).

$$\text{Actual Delay} = \frac{\text{Normalized Delay}}{\text{Actual Corner Frequency (fc) in Hz}}$$



Appendix A

Theoretical Transfer Characteristics

f/fc (Hz)	Amp (dB)	Phase (deg)	Delay ¹ (sec)
0.00	0.00	0.00	.776
0.10	0.005	-28.0	.776
0.20	0.012	-55.9	.776
0.30	0.005	-83.9	.776
0.40	-0.042	-112	.776
0.50	-0.161	-140	.776
0.60	-0.384	-168	.776
0.70	-0.745	-196	.776
0.80	-1.28	-224	.776
0.85	-1.62	-238	.776
0.90	-2.02	-252	.776
0.95	-2.48	-265	.775
1.00	-3.01	-279	.773
1.10	-4.29	-307	.766
1.20	-5.91	-334	.749
1.40	-10.3	-386	.675
1.60	-15.9	-431	.558
1.80	-22.4	-467	.443
2.00	-29.4	-495	.351
2.25	-39.0	-523	.268
2.50	-50.5	-544	.212
2.75	-78.0	-561	.171
3.00	-63.7	-395	.142
3.25	-63.5	-407	.119
3.50	-66.9	-417	.102
3.75	-74.7	-425	.088
4.00	-85.0	-253	.077
4.25	-72.0	-259	.068
4.50	-67.9	-265	.060
4.75	-65.8	-270	.054
5.00	-64.6	-275	.048
5.25	-63.9	-279	.044
5.50	-63.5	-283	.040
5.75	-63.3	-286	.036
6.00	-63.2	-289	.033
6.50	-63.3	-295	.028
7.00	-63.7	-299	.024
8.00	-64.7	-307	.019
9.00	-66.0	-313	.015
10.0	-67.3	-318	.012

1. Normalized Group Delay:

The above delay data is normalized to a corner frequency of 1.0Hz. The actual delay is the normalized delay divided by the actual corner frequency (fc).

$$\text{Actual Delay} = \frac{\text{Normalized Delay}}{\text{Actual Corner Frequency (fc) in Hz}}$$

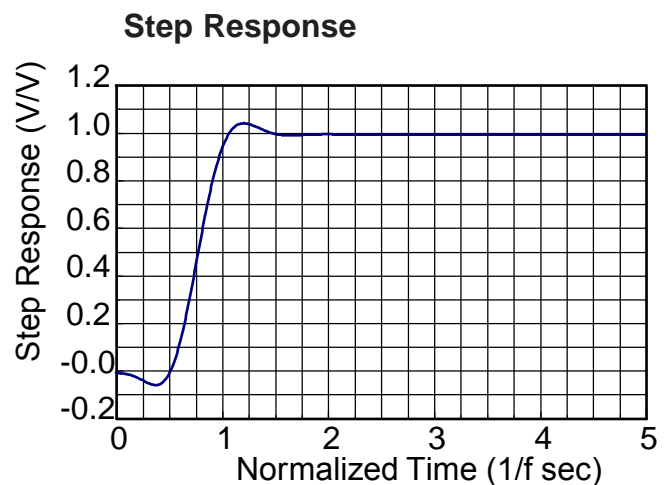
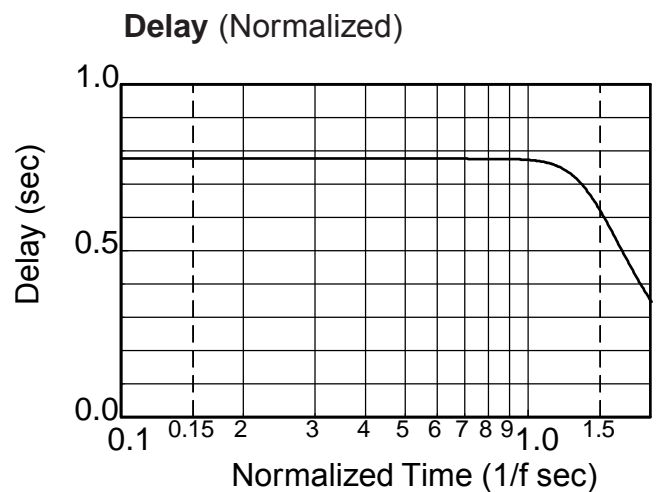
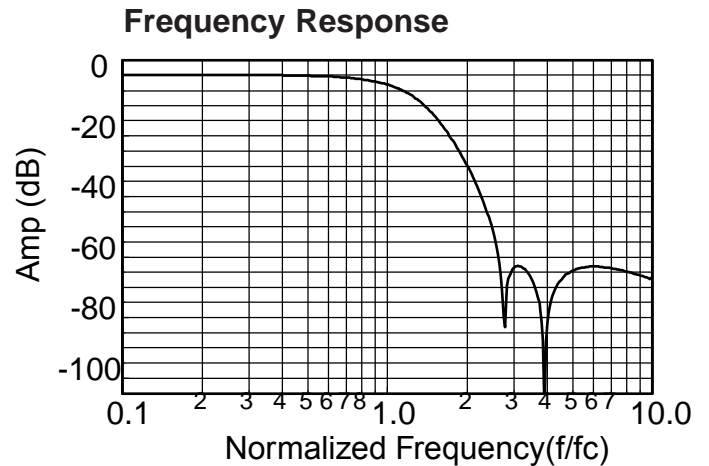



Appendix A

Theoretical Transfer Characteristics

f/fc (Hz)	Amp (dB)	Phase (deg)	Delay ¹ (sec)
0.00	0.00	0.00	.852
0.10	0.017	-30.7	.852
0.20	0.058	-61.3	.852
0.30	0.099	-92.0	.852
0.40	0.105	-123	.852
0.50	0.034	-153	.852
0.60	-0.157	-184	.852
0.70	-0.510	-215	.852
0.80	-1.07	-245	.851
0.85	-1.44	-261	.850
0.90	-1.89	-276	.849
0.95	-2.41	-291	.846
1.00	-3.01	-306	.841
1.10	-4.50	-336	.821
1.20	-6.39	-365	.783
1.40	-11.3	-417	.656
1.60	-17.1	-459	.512
1.80	-23.2	-492	.396
2.00	-29.1	-517	.312
2.25	-36.3	-542	.239
2.50	-43.4	-561	.189
2.75	-50.3	-576	.153
3.00	-57.6	-589	.127
3.25	-62.5	-599	.107
3.50	-75.4	-608	.092
3.75	-98.3	-616	.079
4.00	-86.3	-442	.069
4.25	-84.1	-448	.061
4.50	-85.1	-454	.054
4.75	-87.9	-458	.049
5.00	-92.8	-462	.044
5.25	-104	-466	.040
5.50	-101	-289	.036
5.75	-93.3	-293	.033
6.00	-89.9	-295	.030
6.50	-86.6	-300	.026
7.00	-85.1	-305	.022
8.00	-84.1	-312	.017
9.00	-84.3	-317	.013
10.0	-84.9	-321	.011

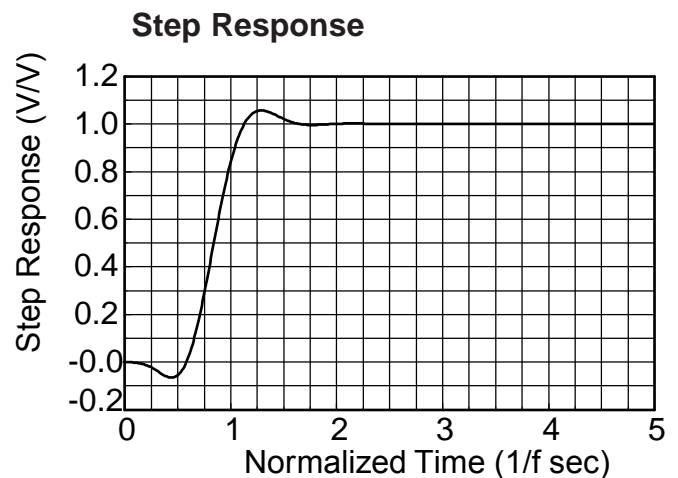
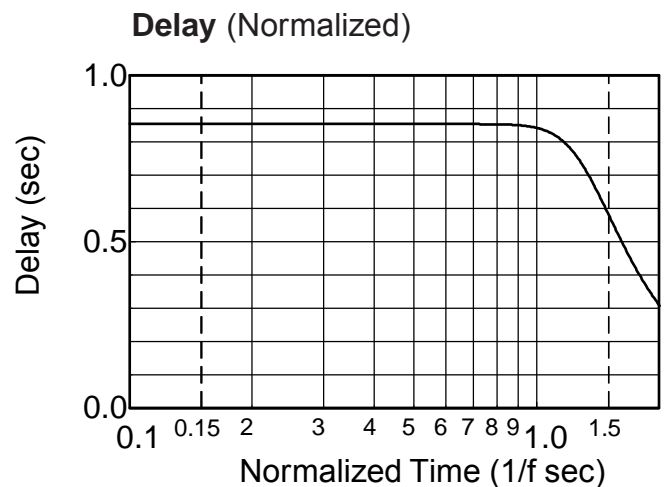
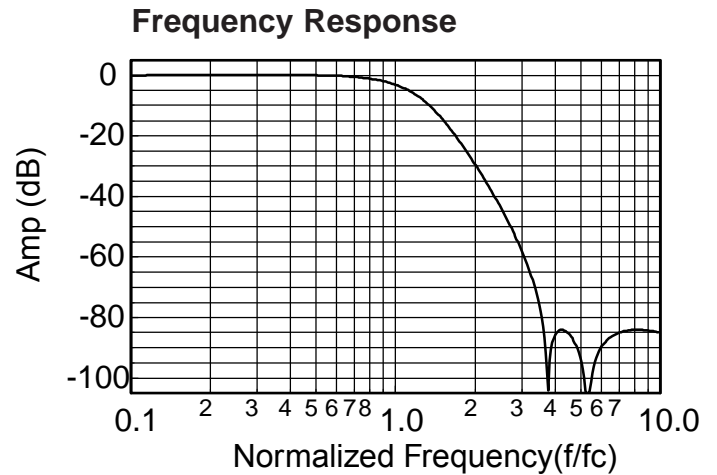

1. Normalized Group Delay:
The above delay data is normalized to a corner frequency of 1.0Hz. The actual delay is the normalized delay divided by the actual corner frequency (fc).

$$\text{Actual Delay} = \frac{\text{Normalized Delay}}{\text{Actual Corner Frequency (fc) in Hz}}$$



Theoretical Transfer Characteristics

f/fc (Hz)	Amp (dB)	Phase (deg)	Delay ¹ (sec)
0.00	0.00	0.00	.865
0.10	0.015	-31.1	.865
0.20	0.051	-62.3	.865
0.30	0.085	-93.4	.865
0.40	0.085	-125	.865
0.50	0.010	-156	.865
0.60	-0.182	-187	.865
0.70	-0.532	-218	.865
0.80	-1.09	-249	.864
0.85	-1.45	-265	.863
0.90	-1.89	-280	.861
0.95	-2.41	-296	.857
1.00	-3.01	-311	.851
1.10	-4.50	-341	.828
1.20	-6.38	-370	.785
1.40	-11.2	-422	.650
1.60	-16.8	-464	.504
1.80	-22.5	-496	.389
2.00	-28.0	-520	.306
2.25	-34.5	-544	.235
2.50	-40.5	-563	.186
2.75	-46.1	-578	.151
3.00	-51.4	-591	.125
3.50	-61.5	-610	.090
4.00	-71.2	-624	.068
4.50	-81.3	-635	.054
5.00	-93.4	-643	.043
5.50	-142	-651	.036
6.00	-105	-476	.030
6.20	-105	-478	.028
6.50	-106	-481	.025
7.00	-110	-486	.022
8.00	-122	-312	.017
9.00	-109	-318	.013
10.0	-106	-322	.011
12.0	-105	-328	.007
14.0	-106	-333	.005
16.0	-107	-336	.004
18.0	-108	-339	.003
20.0	-109	-341	.003

1. Normalized Group Delay:

The above delay data is normalized to a corner frequency of 1.0Hz. The actual delay is the normalized delay divided by the actual corner frequency (fc).

$$\text{Actual Delay} = \frac{\text{Normalized Delay}}{\text{Actual Corner Frequency (fc) in Hz}}$$

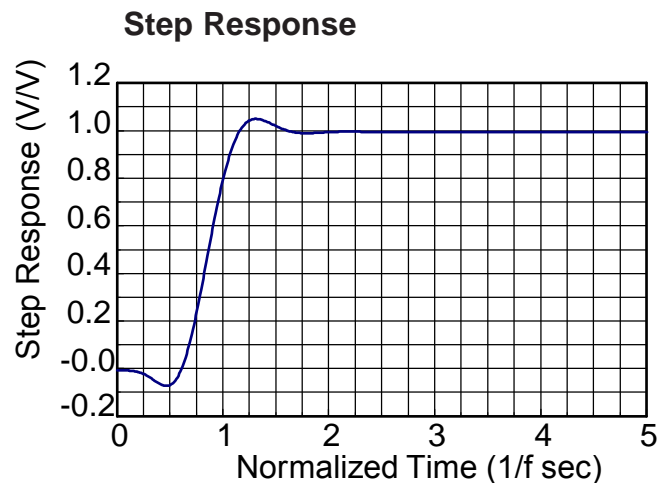
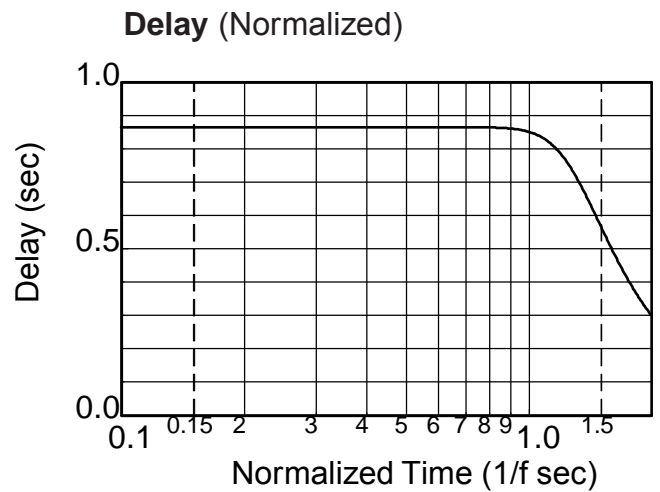
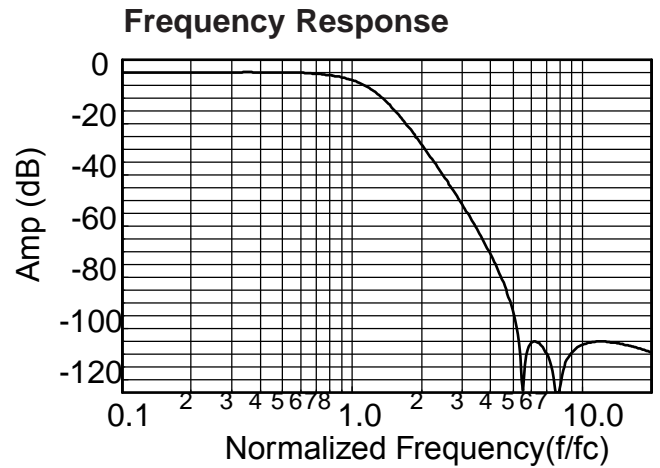



Appendix A

Theoretical Transfer Characteristics

f/fc (Hz)	Amp (dB)	Phase (deg)	Delay ¹ (sec)
0.00	0.00	0.00	0.823
0.10	-0.001	-29.7	0.829
0.20	-0.013	-59.8	0.844
0.30	-0.040	-90.5	0.865
0.40	-0.049	-122	0.904
0.50	-0.018	-156	0.972
0.55	-0.003	-174	1.016
0.60	-0.002	-192	1.064
0.65	-0.019	-212	1.116
0.70	-0.042	-233	1.178
0.75	-0.049	-255	1.264
0.80	-0.026	-279	1.388
0.85	-0.001	-305	1.557
0.90	-0.024	-335	1.767
0.95	-0.045	-369	2.111
1.00	-0.050	-414	3.062
1.10	-10.48	-531	2.043
1.20	-25.96	-576	0.814
1.30	-39.45	-598	0.493
1.40	-52.87	-614	0.348
1.50	-69.11	-624	0.265
1.60	-89.09	-453	0.211
1.70	-85.32	-459	0.174
1.75	-89.95	-463	0.156
1.80	-103.5	-465	0.147
1.85	-95.94	-288	0.158
1.90	-89.31	-290	0.126
1.95	-86.44	-292	0.117
2.00	-84.96	-295	0.110
2.20	-84.54	-302	0.087
2.40	-88.65	-307	0.069
2.60	-99.78	-311	0.057
2.80	-99.97	-135	0.048
3.00	-90.20	-139	0.041
3.50	-85.09	-145	0.029
4.00	-84.04	-150	0.022
5.00	-84.76	-156	0.014
6.00	-86.45	-160	0.009
7.00	-88.31	-163	0.007
8.00	-90.11	-165	0.005
9.00	-91.82	-167	0.004
10.0	-93.41	-168	0.003

1. Normalized Group Delay:

The above delay data is normalized to a corner frequency of 1.0Hz. The actual delay is the normalized delay divided by the actual corner frequency (fc).

$$\text{Actual Delay} = \frac{\text{Normalized Delay}}{\text{Actual Corner Frequency (fc) in Hz}}$$

Frequency Response

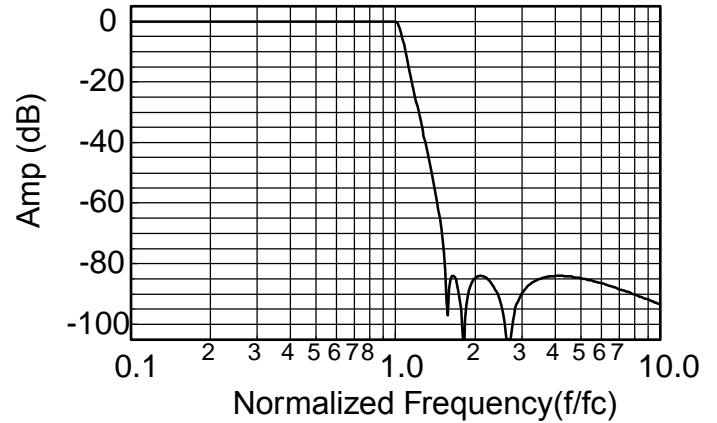

Delay (Normalized)

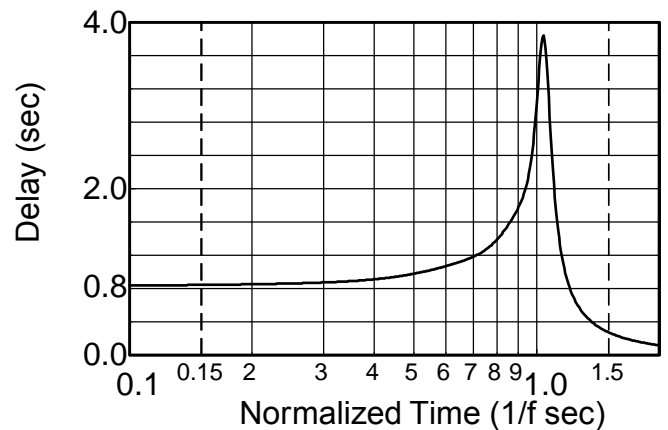

Step Response

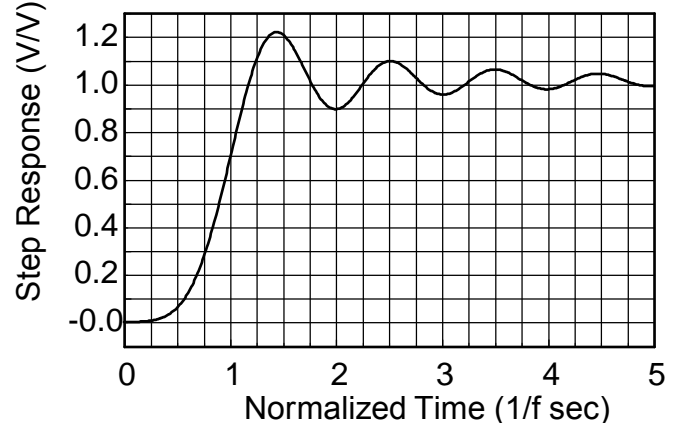



Appendix A

Theoretical Transfer Characteristics

f/fc (Hz)	Amp (dB)	Phase (deg)	Delay ¹ (sec)
0.00	0.00	0.00	0.713
0.10	-0.004	-25.7	0.716
0.20	-0.014	-51.6	0.724
0.30	-0.024	-77.9	0.740
0.40	-0.020	-105	0.767
0.50	0.007	-133	0.811
0.55	0.022	-148	0.840
0.60	0.033	-163	0.872
0.65	0.031	-179	0.908
0.70	0.014	-196	0.946
0.75	-0.015	-213	0.989
0.80	-0.041	-232	1.04
0.85	-0.046	-251	1.12
0.90	-0.016	-272	1.23
0.95	-0.025	-296	1.40
1.00	-0.035	-323	1.65
1.10	-1.76	-392	2.14
1.20	-8.28	-467	1.86
1.30	-18.4	-522	1.19
1.40	-29.3	-558	0.753
1.50	-40.1	-578	0.517
1.60	-51.5	-594	0.381
1.70	-65.2	-606	0.296
1.75	-75.0	-611	0.265
1.80	-113.0	-616	0.239
1.85	-83.6	-440	0.217
1.90	-82.0	-444	0.198
1.95	-83.7	-447	0.182
2.00	-87.8	-450	0.168
2.20	-85.8	-280	0.126
2.40	-82.0	-289	0.099
2.60	-83.5	-295	0.081
2.80	-88.2	-301	0.067
3.00	-99.9	-305	0.057
3.50	-87.2	-134	0.040
4.00	-83.1	-140	0.030
5.00	-82.1	-148	0.018
6.00	-83.1	-154	0.013
7.00	-84.6	-157	0.009
8.00	-86.2	-160	0.007
9.00	-87.8	-163	0.005
10.0	-89.3	-164	0.004

1. Normalized Group Delay:

The above delay data is normalized to a corner frequency of 1.0Hz. The actual delay is the normalized delay divided by the actual corner frequency (fc).

$$\text{Actual Delay} = \frac{\text{Normalized Delay}}{\text{Actual Corner Frequency (fc) in Hz}}$$

Frequency Response

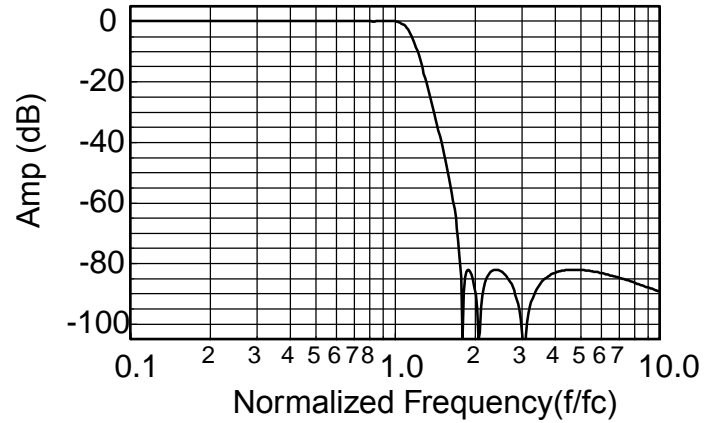

Delay (Normalized)

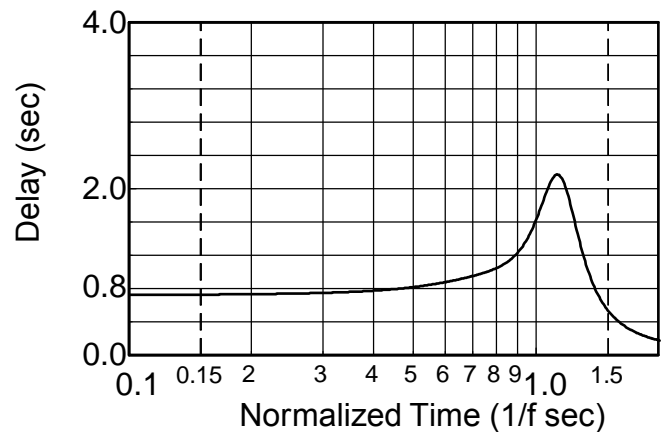

Step Response

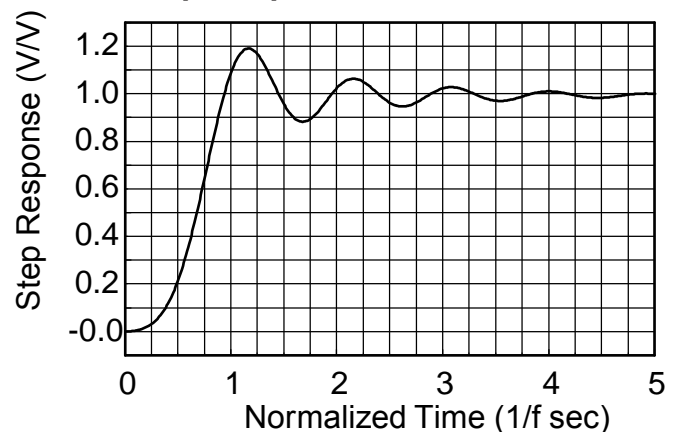



Appendix A

Theoretical Transfer Characteristics

f/fc (Hz)	Amp (dB)	Phase (deg)	Delay ¹ (sec)
0.00	0.00	0.00	0.885
0.10	-0.001	-31.9	0.891
0.20	-0.015	-64.2	0.903
0.30	-0.040	-97.0	0.922
0.40	-0.042	-131	0.958
0.50	-0.001	-166	1.020
0.55	0.000	-185	1.057
0.60	-0.007	-204	1.099
0.65	-0.027	-225	1.140
0.70	-0.045	-245	1.193
0.75	-0.040	-268	1.269
0.80	-0.014	-291	1.377
0.85	-0.001	-317	1.513
0.90	-0.031	-346	1.677
0.95	-0.036	-378	1.960
1.00	-0.046	-419	2.681
1.10	-7.910	-525	2.127
1.20	-21.06	-573	0.856
1.30	-31.96	-597	0.509
1.40	-41.51	-612	0.357
1.50	-50.35	-623	0.271
1.60	-58.90	-632	0.216
1.70	-67.54	-639	0.177
1.75	-72.04	-642	0.162
1.80	-76.79	-645	0.149
1.85	-81.93	-647	0.138
1.90	-87.78	-650	0.128
1.95	-95.04	-652	0.119
2.00	-106.6	-654	0.111
2.20	-106.0	-481	0.087
2.40	-121.3	-307	0.070
2.60	-106.5	-311	0.058
2.80	-105.0	-315	0.049
3.00	-106.4	-318	0.042
3.50	-123.6	-325	0.030
4.00	-111.5	-149	0.022
5.00	-105.4	-156	0.014
6.00	-105.1	-160	0.010
7.00	-106.0	-163	0.007
8.00	-107.3	-165	0.005
9.00	-108.6	-167	0.004
10.0	-110.0	-168	0.003

1. Normalized Group Delay:

The above delay data is normalized to a corner frequency of 1.0Hz. The actual delay is the normalized delay divided by the actual corner frequency (fc).

$$\text{Actual Delay} = \frac{\text{Normalized Delay}}{\text{Actual Corner Frequency (fc) in Hz}}$$

Frequency Response

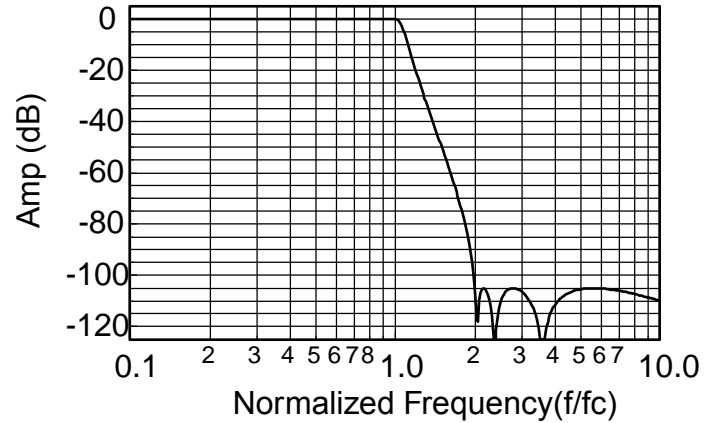

Delay (Normalized)

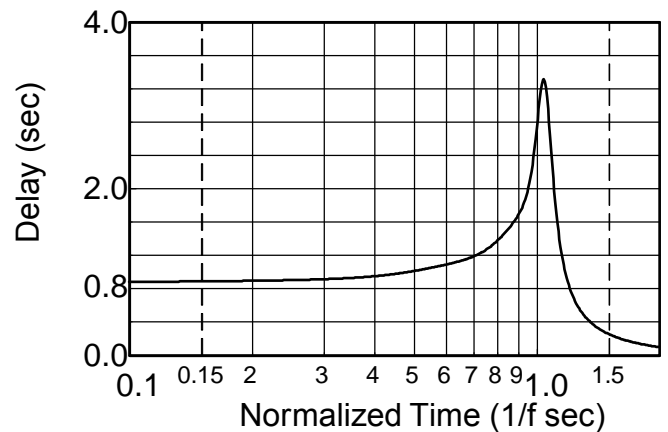

Step Response

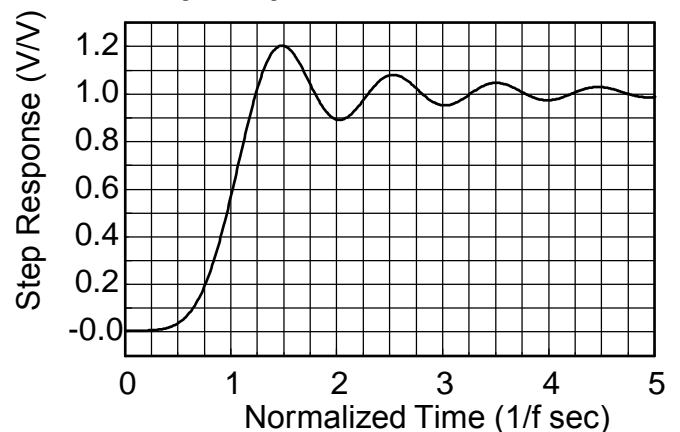



Theoretical Transfer Characteristics

f/fc (Hz)	Amp (dB)	Phase (deg)	Delay ¹ (sec)
0.10	-160	691	0.819
0.20	-112	661	0.828
0.30	-83.7	631	0.843
0.40	-63.7	600	0.867
0.50	-48.2	568	0.903
0.60	-35.5	535	.956
0.70	-24.8	499	1.04
0.80	-15.6	459	1.19
0.85	-11.6	437	1.29
0.90	-8.06	413	1.40
0.95	-5.15	386	1.48
1.00	-3.01	360	1.46
1.20	-0.229	275	0.873
1.40	-0.020	226	0.540
1.60	-0.002	194	0.380
1.80	0.00	170	0.287
2.00	0.00	152	0.226
2.50	0.00	120	0.139
3.00	0.00	99.2	0.094
4.00	0.00	74.0	0.052
5.00	0.00	59.0	0.033
6.00	0.00	49.0	0.023
7.00	0.00	42.1	0.017
8.00	0.00	36.8	0.013
9.00	0.00	32.7	0.010
10.0	0.00	29.4	0.008

Frequency Response

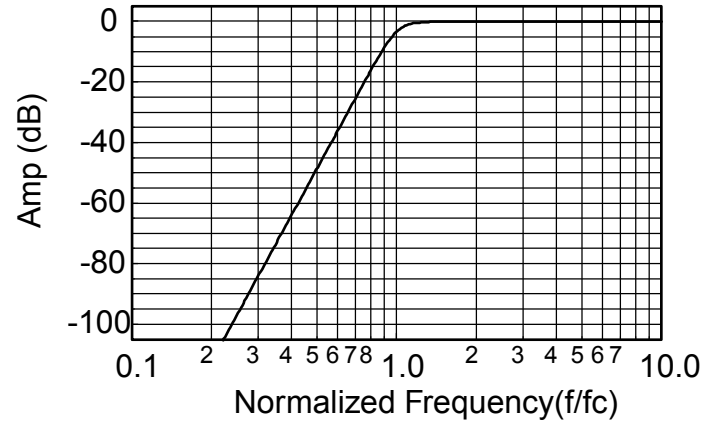

1. Normalized Group Delay:

The above delay data is normalized to a corner frequency of 1.0Hz. The actual delay is the normalized delay divided by the actual corner frequency (fc).

$$\text{Actual Delay} = \frac{\text{Normalized Delay}}{\text{Actual Corner Frequency (fc) in Hz}}$$



Appendix A

Theoretical Transfer Characteristics

f/fc (Hz)	Amp (dB)	Phase (deg)	Delay ¹ (sec)
0.10	-93.4	168	0.334
0.20	-84.8	156	0.344
0.30	-86.0	143	0.363
0.40	-92.6	310	0.392
0.50	-85.0	295	0.439
0.55	-114	287	0.472
0.60	-84.1	458	0.515
0.70	-57.0	617	0.652
0.80	-32.8	589	0.962
0.85	-22.6	569	1.325
0.90	-12.3	538	2.198
0.95	-3.08	483	3.993
1.00	-0.05	414	3.062
1.10	-0.03	341	1.498
1.20	-0.01	296	1.039
1.30	-0.04	264	0.773
1.40	-0.05	239	0.612
1.50	-0.03	219	0.505
1.60	-0.01	202	0.426
1.70	0.00	188	0.364
1.80	0.00	176	0.315
1.90	-0.01	165	0.275
2.00	-0.02	156	0.243
2.50	-0.05	122	0.145
3.00	-0.05	101	0.097
4.00	-0.03	75.1	0.053
5.00	-0.01	59.8	0.034
6.00	-0.01	49.7	0.023
7.00	0.00	42.5	0.017
8.00	0.00	37.2	0.013
9.00	0.00	33.0	0.010
10.0	0.00	29.7	0.008

Frequency Response

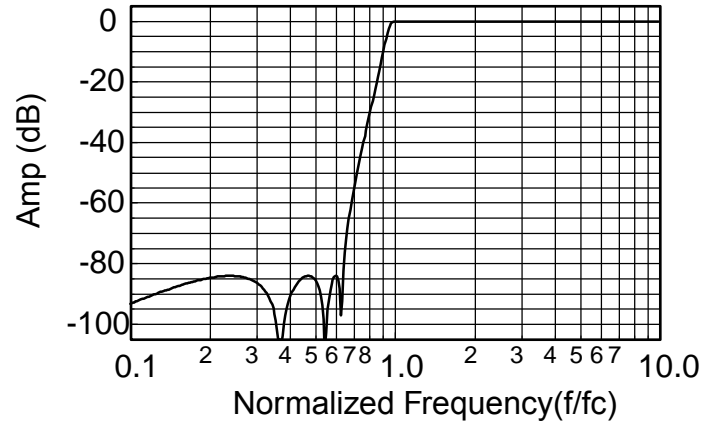

1. Normalized Group Delay:

The above delay data is normalized to a corner frequency of 1.0Hz. The actual delay is the normalized delay divided by the actual corner frequency (fc).

$$\text{Actual Delay} = \frac{\text{Normalized Delay}}{\text{Actual Corner Frequency (fc) in Hz}}$$



Appendix A

Theoretical Transfer Characteristics

f/fc (Hz)	Amp (dB)	Phase (deg)	Delay ¹ (sec)
0.10	-89.3	164	0.440
0.20	-82.1	148	0.459
0.30	-90.6	131	0.495
0.40	-82.4	292	0.559
0.50	-87.8	450	0.671
0.55	-90.0	437	0.761
0.60	-60.2	603	0.890
0.70	-32.4	563	1.37
0.80	-13.1	498	2.35
0.85	-6.28	451	2.77
0.90	-2.21	401	2.66
0.95	-0.51	358	2.15
1.00	-0.03	324	1.64
1.10	-0.01	277	1.04
1.20	-0.05	225	0.757
1.30	-0.03	221	0.596
1.40	0.01	201	0.486
1.50	0.03	185	0.409
1.60	0.03	172	0.347
1.70	0.03	160	0.299
1.80	0.02	150	0.260
1.90	0.01	141	0.229
2.00	0.01	133	0.203
2.50	-0.02	105	0.123
3.00	-0.02	86.9	0.083
4.00	-0.02	64.7	0.046
5.00	-0.01	51.6	0.029
6.00	-0.01	42.9	0.020
7.00	-0.01	36.8	0.015
8.00	-0.01	32.1	0.011
9.00	-0.01	28.6	0.009
10.0	0.00	25.7	0.007

Frequency Response

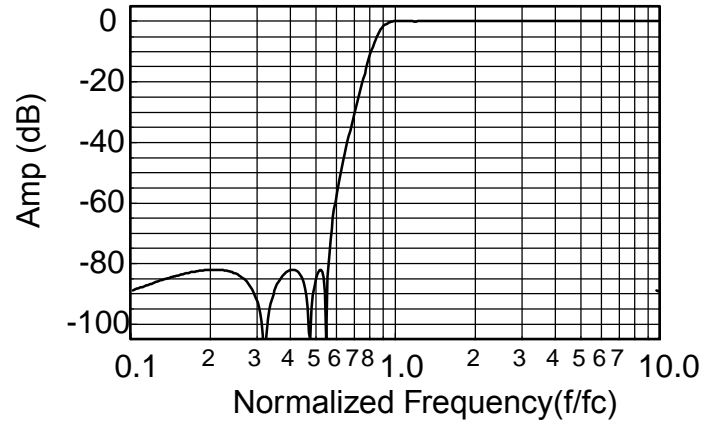

1. Normalized Group Delay:

The above delay data is normalized to a corner frequency of 1.0Hz. The actual delay is the normalized delay divided by the actual corner frequency (fc).

$$\text{Actual Delay} = \frac{\text{Normalized Delay}}{\text{Actual Corner Frequency (fc) in Hz}}$$



Appendix A

Theoretical Transfer Characteristics

f/fc (Hz)	Amp (dB)	Phase (deg)	Delay ¹ (sec)
0.10	-110	168	0.338
0.20	-105	156	0.348
0.30	-114	323	0.367
0.40	-110	309	0.397
0.50	-107	654	0.445
0.55	-78.6	646	0.480
0.60	-64.6	637	0.524
0.70	-44.1	615	0.669
0.80	-26.7	586	1.001
0.85	-18.2	565	1.401
0.90	-9.46	533	2.315
0.95	-2.16	478	3.604
1.00	-0.046	419	2.681
1.10	-0.038	352	1.416
1.20	-0.001	308	1.018
1.30	-0.032	277	0.773
1.40	-0.046	252	0.618
1.50	-0.034	231	0.514
1.60	-0.016	214	0.436
1.70	-0.004	200	0.376
1.80	0.000	187	0.328
1.90	-0.003	176	0.288
2.00	-0.010	166	0.255
2.50	-0.042	131	0.153
3.00	-0.045	108	0.103
4.00	-0.028	80.6	0.057
5.00	-0.015	64.2	0.036
6.00	-0.008	53.4	0.025
7.00	-0.005	45.7	0.018
8.00	-0.003	40.0	0.014
9.00	-0.002	35.5	0.011
10.0	-0.001	31.9	0.009

Frequency Response

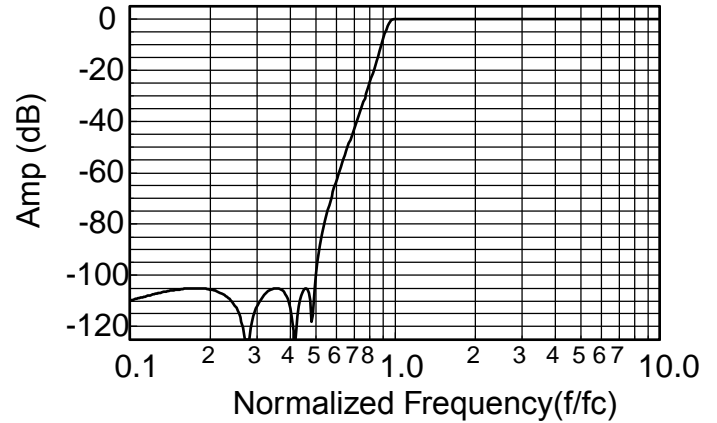

1. Normalized Group Delay:

The above delay data is normalized to a corner frequency of 1.0Hz. The actual delay is the normalized delay divided by the actual corner frequency (fc).

$$\text{Actual Delay} = \frac{\text{Normalized Delay}}{\text{Actual Corner Frequency (fc) in Hz}}$$